

(VITI e DADI PER MONTANTE)
 (SCREWS AND NUTS FOR UPRIGHT)
 SP90414

17 - SP90107
 (x12) (x6) (x4) (x6) (x6)
 SP90122

(x1)
 SP90122

(x1)
 SP90335

(x1)
 SP84025

(x1) (x1) (x1)
 SP84025

(x1)
 SP90121

(x1)
 SP90121

(x1)
 SP90120

(VITI e DADI PER TELAIO)
 (SCREWS AND NUTS FOR FRAME)
 SP90157

(x1)
 SP90340

(x8)
 SP90090

(x1)
 SP97008/C

(x2)
 SP90011

(x2)
 SP90413

16 - SP90404

01 - SP90052

17 - SP97103

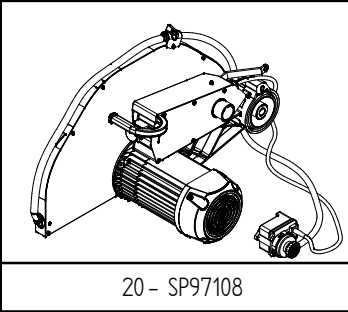
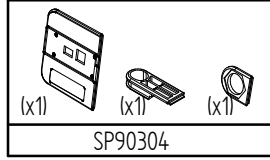
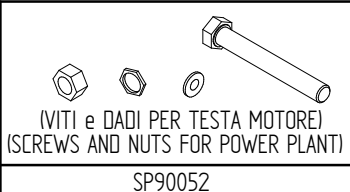

15 - SP90402

15 - SP90402

18 - SP90153

01 - SP90052

19 - SP90414

15 - SP90402

13 - SP90311

01 - SP90052

01 - SP90052

19 - SP90414

19 - SP90414

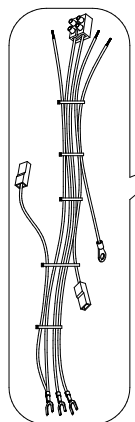
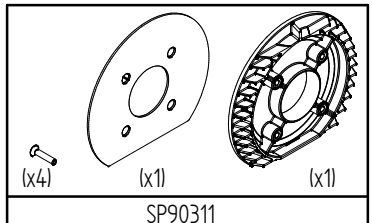
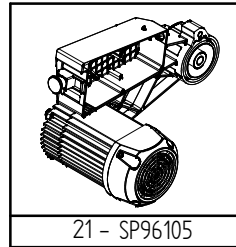

01 - SP90052

26 - SP90326

13 - SP90311

01 - SP90052

01 - SP90052

23 - SP90079

11 - SP90304

01 - SP90052

29 - SP90059

25 - SP90245

27 - SP96125

26 - SP90326

01 - SP90052

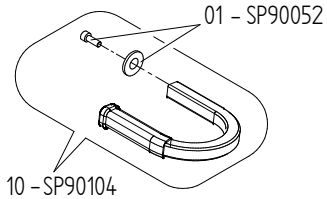

01 - SP90052

03 - SP90319

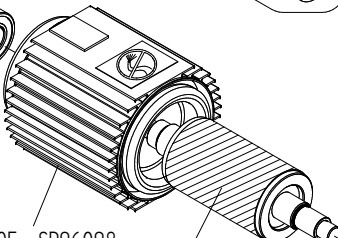

04 - SP90423

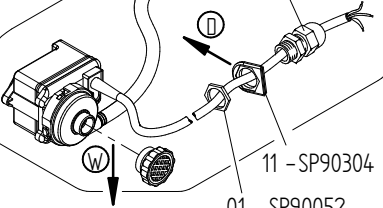

11 - SP90304

01 - SP90052

28 - SP96056

09 - SP90330

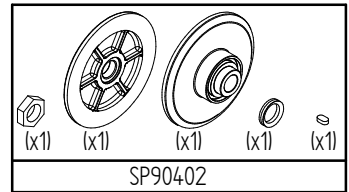

11 - SP90304

12 - SP90329/1

07 - SP90329

01 - SP90052

08 - SP90333

06 - SP97134



03 - SP90319

01 - SP90052

02 - SP90306

01 - SP90052

sp_v6